



akmetal
asansör

ÜRÜN KATALOĞU
product catalog

ABOUT US

HAKKIMIZDA

01

ABOUT US

HAKKIMIZDA

Akmetal Asansör, 1995 yılında Antalya'da kurulmuş olup, faaliyet gösterdiği ilk günden bu yana güven, dürüstlük, emniyet ve koşulsuz müşteri memnuniyetini temel ilke edinmiştir.

Güncel yönetmeliklere ve standartlara uygun teknolojik komponentlerle, mühendislik, montaj, bakım ve modernizasyon alanlarında doğru çözümler sunmayı hedeflemektedir. Kaliteli işçilik, sürdürülebilir hizmet anlayışı ve zamanı verimli kullanma ilkesiyle sektörde güven kazanmıştır.

2013 yılında Antalya Organize Sanayi Bölgesi'nde 6.200 m² alan tahsis edilmiş, 2014'te 4.000 m²'lik fabrika inşaatı tamamlanarak, 2015 yılında asansör kabini ve aksam üretimine başlanmıştır. Üretim ve proje çalışmaları fabrika bünyesinde; satış, servis ve modernizasyon hizmetleri ise ofis adresinden yürütülmektedir.

Akmetal Asansör; dinamik ve üretken kadrosuyla müşterilerinin sadece bugünkü değil, gelecekteki ihtiyaçlarını da öngörmeyi hedefler. Zaman içinde yıpranan veya teknik mevzuata uygunluğunu kaybetmiş sistemler için özel modernizasyon çözümleri sunarak binaların performansını ve güvenliğini artırır.

Her projeye birlikte teknik kapasitesini geliştiren firmamız, etik değerlerden ve kalite anlayışından ödün vermeden, sektörün saygın ve öncü firmalarından biri olma hedefiyle yoluna devam etmektedir.

Akmetal Elevator, established in 1995 in Antalya, has always prioritized trust, integrity, safety, and unconditional customer satisfaction as its core values.

By using advanced technological components aligned with current regulations and standards, we offer precise engineering, reliable installation, maintenance, and modernization services. Our commitment to high-quality workmanship, sustainable practices, and on-time delivery has earned us a trusted place in the industry.

In 2013, we were allocated 6.200 m² in Antalya Organized Industrial Zone. A 4,000 m² factory was completed in 2014, and production of elevator cabins and components began in 2015. While production and project development take place at the factory, sales, service, and modernization are handled from our main office.

Akmetal aims to foresee not only today's needs but also future demands, with a dynamic and productive team. For aging systems or those no longer compliant with regulations, we offer tailor-made modernization solutions that enhance safety and long-term performance.

With every new project, we increase our technical capacity and continue moving forward with a commitment to ethical values and uncompromising quality, striving to be one of the leading and most respected companies in the elevator sector.

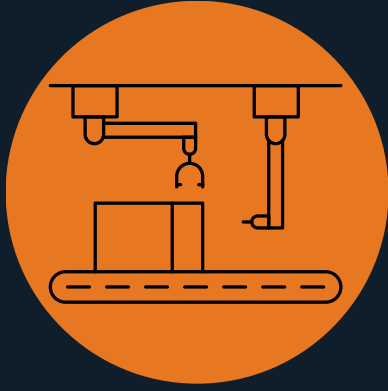

ÜRETİM
production

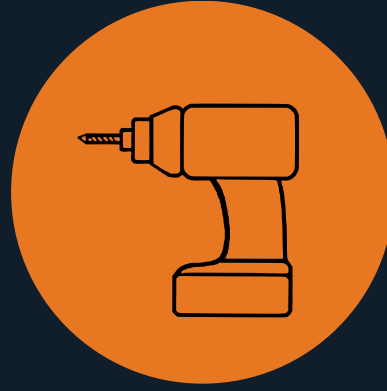

MONTAJ
installation



BAKIM
maintenance



+ 30 YILLIK TECRÜBE

1995 yılında Antalya'da kurulan firmamız faaliyetlerine tüm hızıyla devam etmektedir.
Our company, which was established in Antalya in 1995, continues its activities at full speed.



AOSB ÜRETİM

2014'te 6.200 m²'lik arsa üzerine 4.000 m²'lik fabrika inşaatı tamamlanarak, 2015 yılında asansör kabini ve aksam üretimine başlanmıştır.
The construction of the 4,000 m² factory was completed in 2014, and elevator cabin and component production began in 2015.



TS EN 81-20

Asansörlerin Yapım ve Kurulumu için güvenlik belgesine sahip ilk Akdeniz Bölgesi firması.
The first company in the Mediterranean Region to have a safety certificate for the Construction and Installation of Elevators.



7/24

7/24 Kesintisiz Servis Hizmeti
24/7 Uninterrupted Service



Mustafa YAYLA
Firma kurucusu, founder

FROM OUR FOUNDER KURUCUMUZDAN

1995 yılında çıktığımız bu yolda, en büyük önceliğimiz her zaman güven, dürüstlük ve insan hayatı oldu. Tek bir asansör montajı bile bizim için sadece bir iş değil; insanların sevdiklerine güvenle ulaşması, hayatlarını kolaylıkla ve huzurla sürdürebilmesi demektir. Çünkü biz, yaptığımız her işi büyük bir sorumluluğun parçası olarak gördük.

Bugün Akmetal, geçmişten aldığı deneyimi teknolojinin gücüyle birleştiriyor. Sürekli gelişen sektöre uyum sağlayarak kalite ve güvenlik standartlarımızı her geçen gün daha ileri taşıyoruz. Ekibimizle birlikte her gün daha iyisi için çalışıyor; sadece ürün değil, güvenli, konforlu ve sürdürülebilir yaşam alanları sunuyoruz.

Geleceğe umutla bakan, sağlam adımlarla ilerleyen bir şirket olmanın gururunu yaşıyor; değerlerimizden ödün vermeden yarınlara yürümeye devam ediyoruz.

Since our establishment in 1995, our highest priorities have always been trust, integrity, and human life. For us, even a single elevator installation has never been just a job; it has meant enabling people to reach their loved ones safely and to continue their lives with ease and peace of mind. Because we have always regarded every project we undertake as part of a great responsibility.

Today, Akmetal combines the experience gained from the past with the power of modern technology. By adapting to the ever-evolving industry, we continuously elevate our quality and safety standards. Together with our team, we strive every day to do better—offering not only products, but also safe, comfortable, and sustainable living spaces.

We take pride in being a company that looks to the future with hope and moves forward with confident steps, continuing our journey without compromising our core values.



CONTENTS

İÇİNDEKİLER

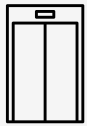

KAPILAR
DOORS

9-10

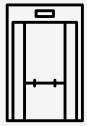

KABINLER
CABINS

11-15



KAPLAMA MALZEMELERİ
COATING MATERIALS

16-17



KAT BUTONYERLERİ
LANDING OPERATING PANEL

18-19



KABİN BUTONYERLERİ
STATIONS

20-21



AKSESUARLAR
ACCESSORIES

22



DİĞER ÜRÜN GRUPLARI
OTHER PRODUCT GROUPS

23-25



REFERANSLAR
REFERENCES

26-26



CW Enerji (AOSB)



Budak Kağıtçılık (AOSB)



Sayın Prefabrik

KAPILAR/DOORS

2 PANEL TELESKOPIK /2 PANEL TELESCOPIC



satine paslanmaz
satin stainless steel

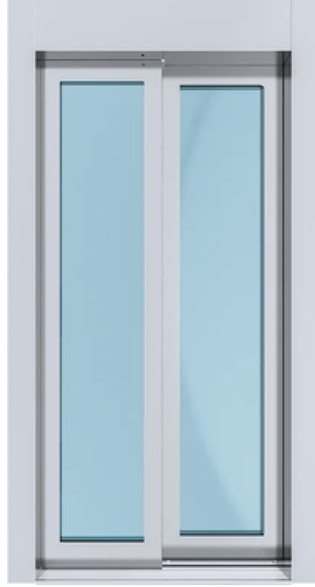

çerçeve camlı
frame glass

2 PANEL MERKEZİ /2 PANEL CENTRAL



satine paslanmaz
satin stainless steel

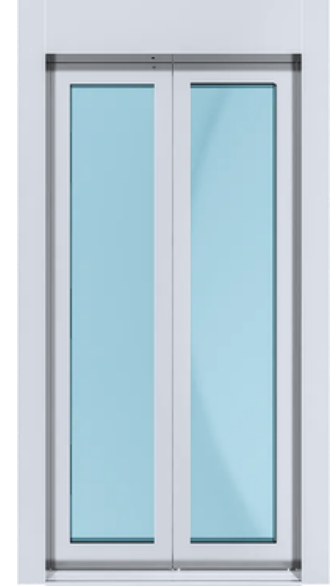

çerçeve camlı
frame glass

*Görseller temsili olup, baskıdan kaynaklı ton ve detay farklılıkları gösterebilir. / *Images are for illustrative purposes only and may vary due to printing differences.*

■ **3 PANEL TELESKOPIK**
/3 PANEL TELESCOPIC



satine paslanmaz
satined stainless steel

■ **4 PANEL MERKEZI**
/4 PANEL CENTRAL



satine paslanmaz
satined stainless steel



KABİNLER/CABINS



AKM-1001

Yan Duvar : Satine Paslanmaz
/Side Wall : Satin Stainless Steel
Arka Duvar: Satine Paslanmaz + Ayna
/Back Wall : Satin Stainless Steel + Mirror



AKM-1002

Yan Duvar : Satine + Nokta Paslanmaz
/Side Wall : Satin + Dot Stainless Steel
Arka Duvar: Satine+Nokta Paslanmaz + Ayna
/Back Wall : Satin + Dot Stainless Steel + Mirror



AKM-1003

Yan Duvar : Satine Paslanmaz + Beyaz Cam
/Side Wall : Satin Stainless Steel + White Glass
Arka Duvar: Satine Paslanmaz + Ayna
/Back Wall : Satin Stainless Steel + Mirror

*Tavan, taban ve kabin kaplama renk ile malzemeleri deęiřtirilebilir ve iřteęe gre zelleřtirilebilir./Ceiling, floor, and cabin cladding colors and materials can be modified and customized upon request.

KABİNLER/CABINS



AKM-1004

Yan Duvar : Satine Paslanmaz + Beyaz Cam + Led Kanal
/Side Wall : Satin Stainless Steel + White Glass +Led Line
Arka Duvar: Satine Paslanmaz +Ayna
/Back Wall : Satin Stainless Steel + Mirror



AKM-1005

Yan Duvar : Satine Paslanmaz + Beyaz Cam
/Side Wall : Satin Stainless Steel + White Glass
Arka Duvar: Satine Paslanmaz + Ayna
/Back Wall : Stainless Steel + Mirror



AKM-1006

Yan Duvar : Satine Paslanmaz
/Side Wall : Satin Stainless Steel
Arka Duvar: Satine Paslanmaz + Ayna
/Back Wall : Stainless Steel + Mirror

*Tavan, taban ve kabin kaplama renk ile malzemeleri deęiřtirilebilir ve isteęe gore ozelleřtirilebilir. /Ceiling, floor, and cabin cladding colors and materials can be modified and customized upon request.

KABİNLER/CABINS



AKM-1007

Yan Duvar : Satine Paslanmaz + Mavi Cam
/Side Wall : Satin Stainless Steel + Blue Glass
Arka Duvar: Satine Paslanmaz + Ayna
/Back Wall : Stainless Steel + Mirror



AKM-1008

Yan Duvar : Elektrostatik Boya
/Side Wall : Electrostatic Painted
Arka Duvar: Elektrostatik Boya + Ayna
/Back Wall : Electrostatic Painted + Mirror



AKM-1009

Yan Duvar : Dekoratif Panel
/Side Wall : Decorative Panel
Arka Duvar: Dekoratif Panel + Ayna
/Back Wall : Decorative Panel + Mirror

*Tavan, taban ve kabin kaplama renk ile malzemeleri deęiřtirilebilir ve iřteęe gre zelleřtirilebilir./Ceiling, floor, and cabin cladding colors and materials can be modified and customized upon request.

KABİNLER/CABINS



PANORAMİK *triview*

Yan Duvar : Paslanmaz Kaplama + Cam
/Side Wall : Stainless Steel + Glass
Arka Duvar: Satine Paslanmaz + Cam
/Back Wall : Stainless Steel + Glass



PANORAMİK *monoview*

Yan Duvar : Paslanmaz Kaplama
/Side Wall : Stainless Steel
Arka Duvar: Satine Paslanmaz + Cam
/Back Wall : Stainless Steel + Glass



PANORAMİK *360view*

Yan Duvar : Paslanmaz Kaplama
/Side Wall : Stainless Steel
Arka Duvar: Satine Paslanmaz + Kavisli Cam
/Back Wall : Stainless Steel + Curve Glass

*Tavan, taban ve kabin kaplama renk ile malzemeleri değiştirilebilir ve isteğe göre özelleştirilebilir./Ceiling, floor, and cabin cladding colors and materials can be modified and customized upon request.

2

▲ 0

DESIGNED FOR
SEAMLESS INTEGRATION

Mekanla bütünleşen tasarım

Yüksek kaliteli malzemeler kullanılarak üretilen bu asansörler, modern mimariye mükemmel bir entegrasyon sağlar. Güvenli ve konforlu bir yolculuk için tasarlanmıştır.



Yüksek kaliteli malzemeler kullanılarak üretilen bu asansörler, modern mimariye mükemmel bir entegrasyon sağlar. Güvenli ve konforlu bir yolculuk için tasarlanmıştır.

KAPLAMA SEÇENEKLERİ /COATING OPTIONS

PASLANMAZ ÇELİK SEÇENEKLERİ /STAINLESS STEEL OPTIONS

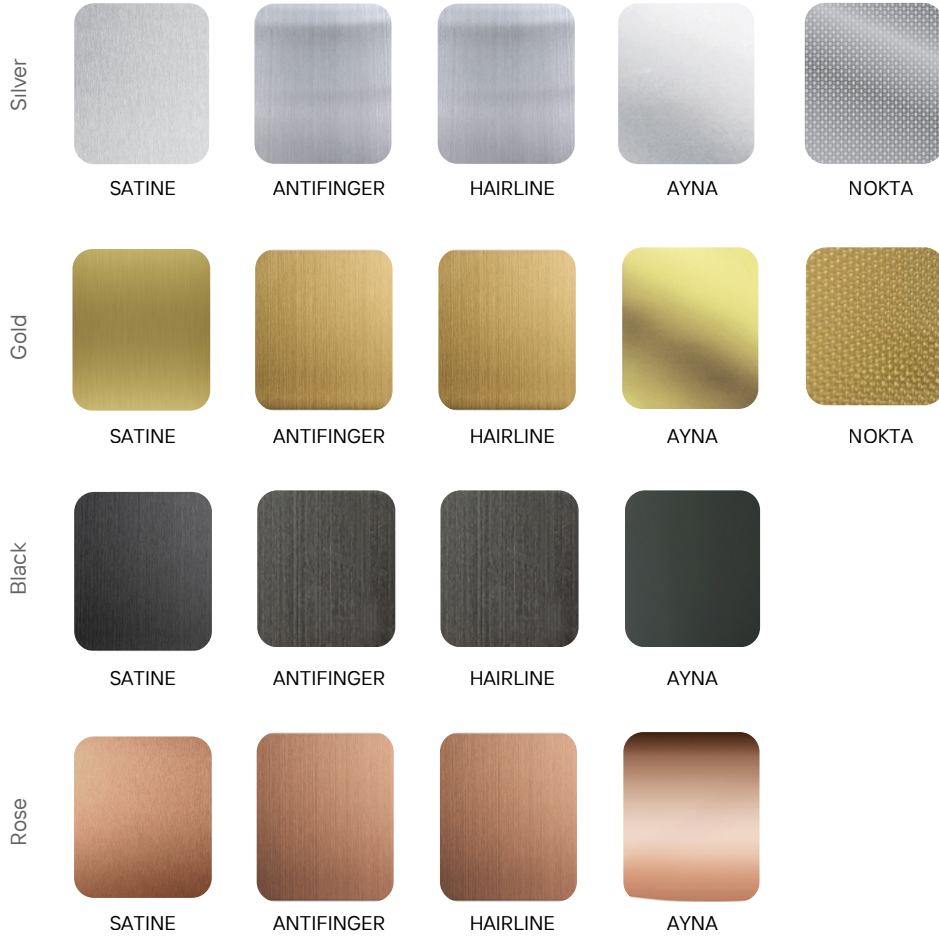

ELEKTROSTATİK BOYA /ELECTROSTATIC PAINTED



CAM SEÇENEKLERİ /GLASS OPTIONS



*Farklı renk seçenekleri ve dijital baskı uygulamaları için yetkilimizle iletişime geçebilirsiniz.
/For alternative color options and digital printing applications, please contact our representative.

*İstenen diğer RAL renkleri uygulanabilmekte olup, detaylı bilgi için yetkilimizle iletişime geçebilirsiniz.
/Other requested RAL colors can be applied. Please contact our representative for further details.

*Bu katalogta yer alan RAL renkleri, baskı ve ekran ayarlarından etkilenmiş olabilir. Gerçek renkleri görebilmek için lütfen orijinal RAL renk kataloğuna başvurunuz. /The RAL colors shown in this catalog may be affected by printing and display settings. For accurate color matching, please refer to the official RAL color chart.

■ TAVANLAR/CEILINGS

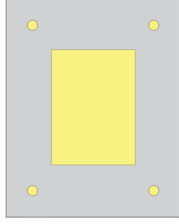

T01

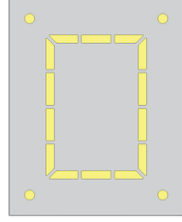

T02

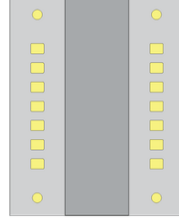

T03

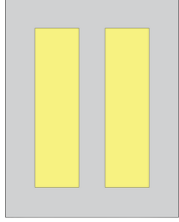

T04

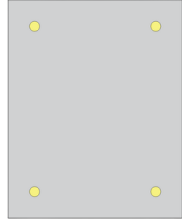

T05

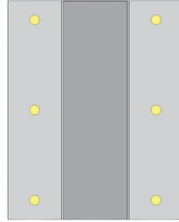

T06

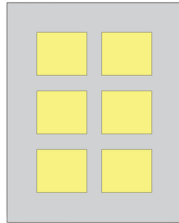

T07

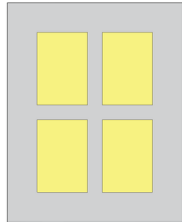

T08

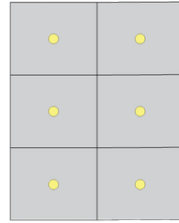

T09

■ TABANLAR/FLOORS

■ PVC/PVC



RBTS1317



RBTS1312

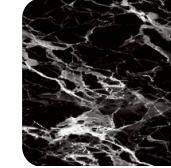

RBTS1316



SST05

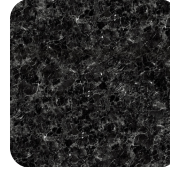

RBTS1320



RBTS1319



S13416

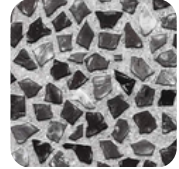

STU62

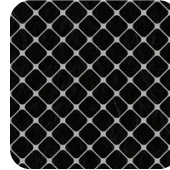

RBTS1314

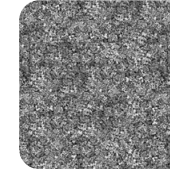

RBTS1318



SSY192



SST12

■ Seramik, mermer gibi malzemeleri taban olarak kullanmak için yetkililerimizle iletişime geçebilirsiniz. /You can contact our representatives to use materials such as ceramics and marble as a base.

KAT BUTONYERLERİ /LANDING OPERATING PANEL

A SERİSİ/A SERIES

TEK ASANSÖR İÇİN / FOR SINGLE ELEVATOR



ANOVA601



AARC201 (SA)



AQD901



AARM101



AINKA701



ANOVA611



AARC211 (SA)



AQD911



AARM111



AINKA711

ÇİFT ASANSÖR İÇİN / FOR MULTIPLE ELEVATORS



AARC221 (SA)



AQD921



AARM121



AINKA721

Cam renk seçenekleri
/Glass color options



Metal renk seçenekleri
/Metal color options



Buton seçenekleri
/Button options



Göstergeler
/Indicators



*Modeller tek butonlu veya çift butonlu tercih edilebilir. / Models can be preferred with single button or double button.

KAT BUTONYERLERİ /LANDING OPERATING PANEL

W SERİSİ/W SERIES

TEK ASANSÖR İÇİN / FOR SINGLE ELEVATOR

ÇİFT ASANSÖR İÇİN / FOR MULTIPLE ELEVATORS

Ana seçenekler
/Main options



WPGTB281



WPGSTB281



WPSXTB251



WGST301



WLST281



WLST361



WPGT281



WPGST281



WPSXT251



WPGST281



WSGT301



WSGST301

Ana seçenekler
/Main options



WLST2822



WPSXT2521



WPGT2822



WSGT321

Diğer seçenekler
/Other options



WGSTB251



WLG281



WGST301



WSKMT301



WSKT302



WSKT301

Diğer seçenekler
/Other options



WGST322



WGST321

Cam renk seçenekleri
/Glass color options



Metal renk seçenekleri
/Metal color options



Buton seçenekleri
/Button options



Göstereçler
/Indicators



KABİN BUTONYERİ /CAR OPERATION PANEL

A SERİSİ/A SERIES

Ana seçenekler
/Main options



ANOVA651SD



AARC261



AQD962



AARM161



AINKA761

Diğer seçenekler
/Other options



ANOVA651MD



ANOVA451PT

Cam renk seçenekleri
/Glass color options



Metal renk seçenekleri
/Metal color options



Buton seçenekleri
/Button options



Göstereçler
/Indicators



KABİN BUTONYERİ /CAR OPERATION PANEL

W SERİSİ/W SERIES

Ana seçenekler
/Main options

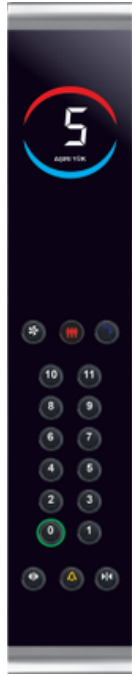

WPGN1000SM



WLGPN2000



WLSPN2000SM



WLSPN2000



WLSPLY1000



WSGNY1000

Diğer seçenekler
/Other options



WSGN2000



WSGN2000SM



WSGTP2001



WSGTP2001

Cam renk seçenekleri
/Glass color options



Metal renk seçenekleri
/Metal color options



Buton seçenekleri
/Button options



Göstereçler
/Indicators



AKSESUARLAR /ACCESSORIES

KAPI ÜSTÜ KAT GÖSTERGELERİ /LANDING INDICATORS



WGIA320



ANOVA631



ANOVA631D

KÜPEŞTELER/HANDRAILS



K01



K02



K03

Metal renk seçenekleri
/Metal color options





DISCOVER

THE HOMELIFT

Homelift'i Keşfedin

DİĞER ÜRÜN GRUPLARI /OTHER PRODUCT GROUPS

ENGELLİ PLATFORMU /FREIGHT ELEVATOR(GOODS LIFT)



- Düşük katlı yapılar /Low-rise buildings
- Engelli erişimi /Accessibility solutions
- İç / dış mekan kullanımı /Indoor/outdoor use

MONŞARJ /DUMBWAITER (SERVICE LIFT)



- Restoran / otel / villa /Restaurants / hotels / villas
- Küçük yük taşıma /Small load transport
- Kompakt çözüm /Compact solution

Endüstriyel ve servis kullanımına yönelik platform ve lift çözümleri, güvenli, dayanıklı ve verimli taşıma deneyimi sunar.

Platform and lift solutions for industrial and service use, offering safe, durable, and efficient transportation.

DİĞER ÜRÜN GRUPLARI /OTHER PRODUCT GROUPS

ARAÇ ASANSÖRÜ /CAR LIFT



- Otopark çözümleri için idealdir. /Ideal for parking solutions.
- Alan tasarrufu sağlar. /Provides space-saving advantages.
- Villa ve ticari projelere uygundur. /Suitable for residential and commercial projects.

YÜK ASANSÖRÜ /FREIGHT ELEVATOR

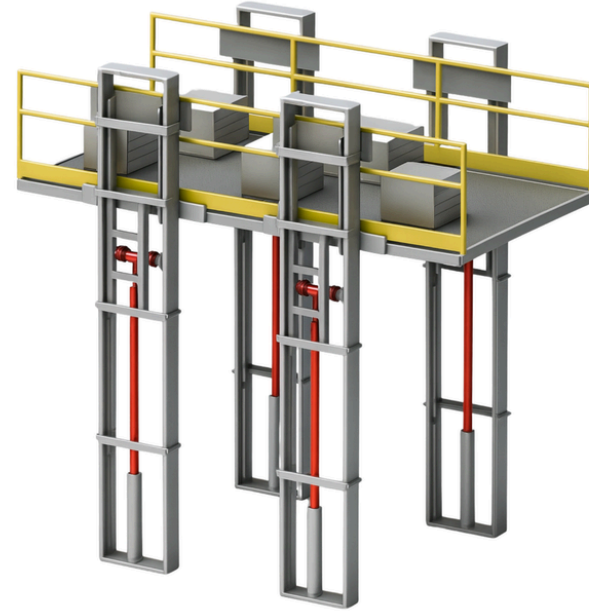

- Ağır yük taşımaya uygun. /Designed for heavy-duty load transportation.
- Endüstriyel kullanım için tasarlanmıştır. /Suitable for industrial applications.
- Yüksek taşıma kapasitesi sunar. /Offers high load capacity.



akmetal asansör

Akmetal Asansör Üretim Tesisi



■ AOSB Teknopark



■ Pera Plaza
(Pera Yapı Merkez Ofis)



■ Akdeniz Üniversitesi
İletişim Fakültesi

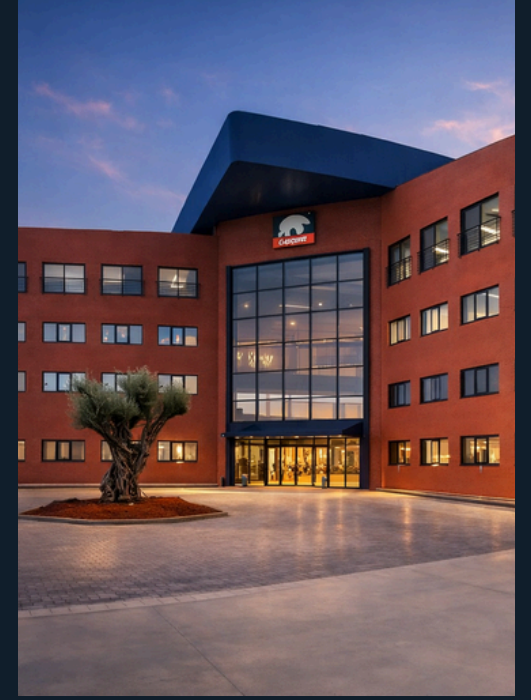

■ Fiberli (PSL Elektronik)

REFERANSLAR / REFERENCES



■ CW Enerji



■ Best Western Khan Otel

- Akdeniz Üniversitesi Mimarlık Fakültesi
- Akant Koleji
- Orbit Göz Hastanesi
- Özderin Avukatlık
- Antalya Organize Sanayi Bölge Müdürlüğü
- Budak Kağıtçılık
- Akdeniz Dondurma
- Vib Best Western Otel
- Gökay Twins
- 100.Yıl Plaza
- Muratpaşa Belediyesi Sivil Toplum Merkezi
- Pera Tower
- Pera Corner
- Pera Port
- Pera 34
- Pera Studio
- Adalya İnşaat
- On Otelcilik Utopia Resort
- On Otelcilik Utopia Beach
- Aska Just in Beach
- Aktaş Oto Lastik
- Ofis Plaza
- Sahil Yapı Denetim
- Cihanalp İnşaat
- Ural İnşaat
- Berrak Petrol
- Oktaylar Tekstil
- Akdeniz Endüstri Grup
- Lara Posta Dağıtım Merkezi
- Kremlin Residence
- Büyükkada Sitesi
- Atakons Residence
- Atakons Suit
- Gökay Dayanıklı Tüketim Malları

*Bu katalogta yalnızca seçili projelerimiz yer almaktadır. Diğer referanslarımız talep üzerine paylaşılabilir./ This catalog includes only selected projects. Additional references are available upon request.

MİMARLIK EL KİTABI

ARCHITECTURAL HANDBOOK

Mimari planlama için teknik rehber.
/Technical specifications for precise architectural planning.

plan

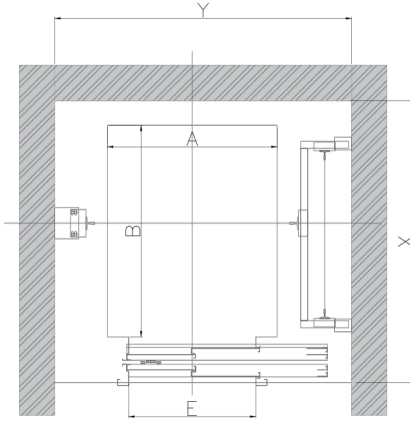

kesit

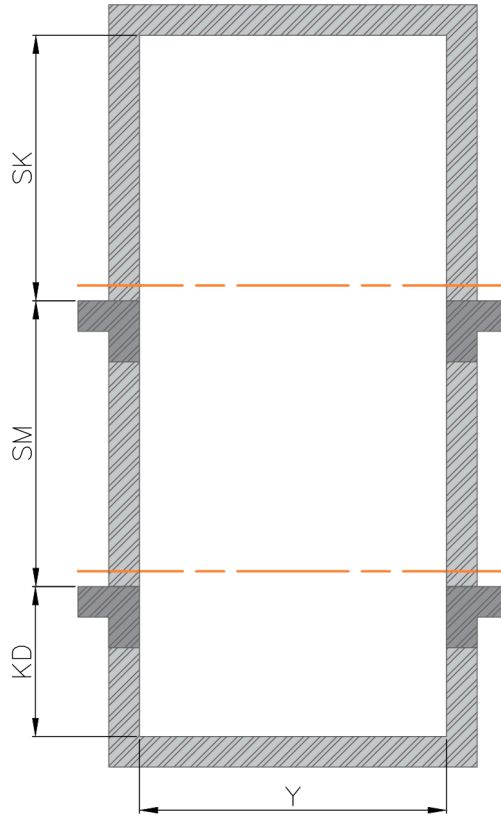

akmetal
asansör

akmetal
asansör

kapasite (capacity)	kabin alanı (cabin space)	X	Y	A	B	E	1 m/sn hız (1 m/s speed)		1,6m/sn hız (1,6 m/s speed)	
							KD	SK	KD	SK
630 KG	1,45-1,66 m ²	1900 mm	1900 mm	1100 mm	1400 mm	900 mm	1500 mm	4000 mm	1750 mm	4250 mm
800 KG	1,8-2,0 m ²	2100 mm	2000 mm	1200 mm	1500 mm	900 mm	1500 mm	4000 mm	1750 mm	4250 mm
1000 KG	2,15-2,4 m ²	2100 mm	2300 mm	1200 mm	1800 mm	900 mm	1500 mm	4000 mm	1750 mm	4250 mm
*1275 KG	2,71-2,95 m ²	2100 mm	2800 mm	1200 mm	2300 mm	1100 mm	1700 mm	4100 mm	1950 mm	4350 mm
*1275 KG	2,71-2,95 m ²	2500 mm	2600 mm	1300 mm	2100 mm	1100 mm	1700 mm	4100 mm	1950 mm	4350 mm
*1600 KG	3,36 m ²	2400 mm	3000 mm	1400 mm	2400 mm	1300 mm	1800 mm	4100 mm	2000 mm	4350 mm

kapasite (kişi) (person capacity)	kapasite (kg) (kg capacity)	kabin alanları (m ²) (cabin space m ²)
6	450	1,17-1,30
6	480	1,17-1,38
7	525	1,31-1,45
8	600	1,45-1,60
8	630	1,45-1,66
9	675	1,59-1,75
10	750	1,73-1,90
10	800	1,73-2,0
11	825	1,87-2,05
12	900	2,01-2,20
13	975	2,15-2,35

kapasite (kişi) (person capacity)	kapasite (kg) (kg capacity)	kabin alanları (m ²) (cabin space m ²)
13	1000	2,15-2,40
14	1050	2,29-2,50
15	1125	2,43-2,65
16	1200	2,57 - 2,80
17	1275	2,71 - 2,95
18	1350	2,85 - 3,10
19	1425	2,99 - 3,25
20	1500	3,13 - 3,40
21	1600	3,25 -3,56
27	2000	3,94 - 4,20
33	2500	4,63 - 5,0

*1275 kg ve üzeri asansörler sedye kullanımına uygundur. /Elevators with a capacity of 1275 kg and above are suitable for stretcher use.

*2500 kg sonrasında her ilave 100 kg için 0,16 m² eklenir. /For every additional 100 kg after 2500 kg, 0.16 m² is added.

*20 kişiden sonra her bir kişi için 0.115 m² eklenir. /An additional 0.115 m² is added for each person after the 20th person.

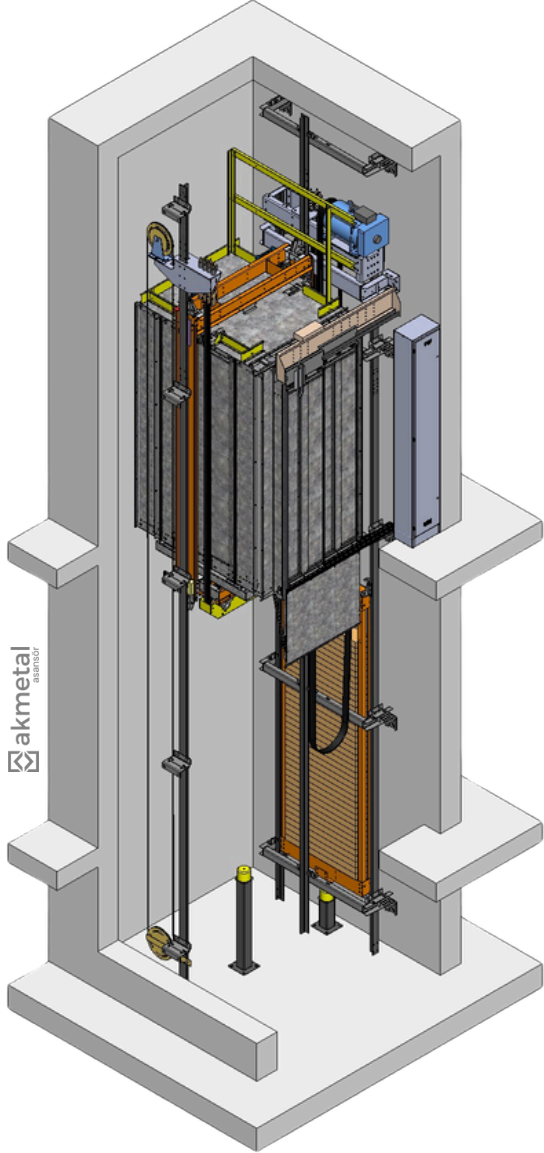

MAKİNE DAİRESİZ ASANSÖR
ELEVATOR WITHOUT MACHINE ROOM

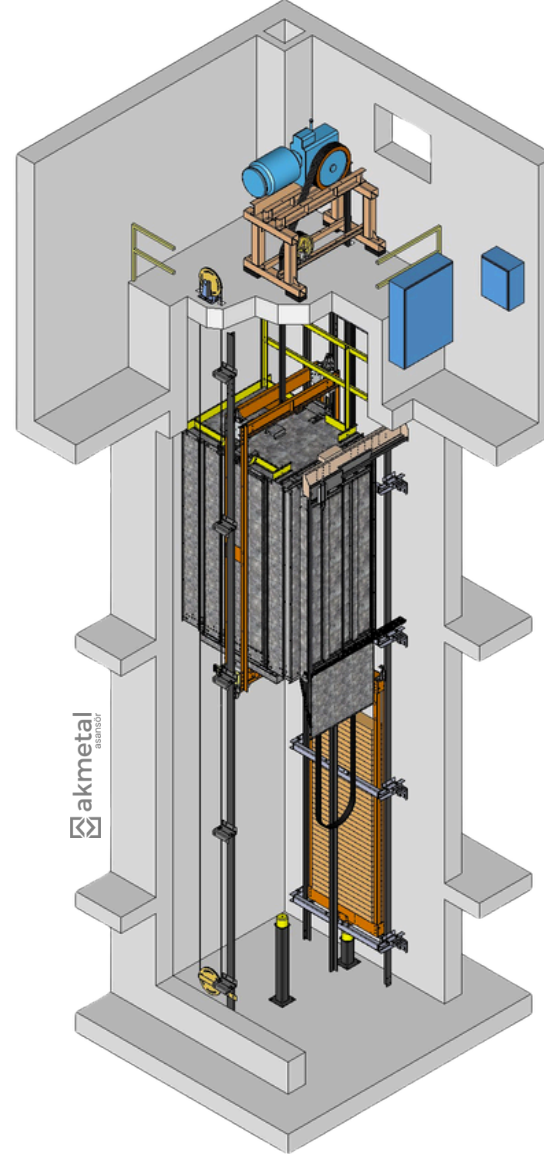

MAKİNE DAİRELİ ASANSÖR
ELEVATOR WITH MACHINE ROOM



İLETİŞİM
CONTACT US



Cumhuriyet Mah. 635 Sk. No:5/A
Muratpaşa / ANTALYA



Antalya Organize Sanayi Bölgesi 1. Kısım
6. Cadde No:7 Döşemealtı / ANTALYA



0(242) 313 12 09



www.akmetalasansor.com



akmetal@akmetalasansor.com